

FloorBed 1-Plus Instruction Manual

IFU-FL5-001EN REV 05

Contents

Title	Page
Welcome	2
General warnings	3
1. Means of delivery	4
2. Safety Instructions	4
3. Intended use	4
4. Technical specification	4
5. Accessories	5
6. Electrical specification	5
7. Assembly	6
8. Bed controls and indicators	8
9. Floor-Level function	9
10. Functionality check	10
11. Using the castor brakes	10
12. Mattress selection	10
13. Siderail selection	10
14. Disassembly	11
15. Moving and Repositioning	11
16. Cleaning & Disinfection	11
17. Troubleshooting	12
18. Storage	12
19. Daily inspection	12
20. General maintenance	12
21. Guarantee	13
22. Disposal	13
23. EMC Statement	14
24. Table of symbols	18
25. Contact details	19

Design Policy and Copyright

® And ™ are trademarks belonging to Accora Ltd unless otherwise stated. As our policy is one of continuous improvement, we reserve the right to modify designs without prior notice. © Accora Ltd 2019.

Welcome

Dear Customer,

Thank you for purchasing an Accora healthcare product. Before operating the bed, you must read and understand all the instructions in this manual. All actions and handling of the bed must be performed in accordance with the instructions in this manual.

Please ensure that the manual is available to users and operators throughout the bed's service life.

If you need further information, please contact us. See section 25 for region specific contact details.

Before operating the bed, you must read and understand all the instructions in this user manual. All actions and handling of the bed must be performed in accordance with the instructions in this manual.

Any actions that are inconsistent with the manual are performed at your own risk and Accora shall not be liable for any injury or damage. Please ensure that the manual is available to users and operators throughout the bed's service life.

General

The FloorBed is classified as a Medical Device Class 1 in accordance with the Medical Devices Regulation 2002 as amended and the Medical Device Regulation 2017/745.



Notice to User

If a serious incident occurs in relation to this medical device, affecting the user or the patient, then the user or patient should report the serious incident to the medical device manufacturer (or distributor) and, in the European Union, the user should also report the serious incident to the Competent Authority in the member state where they are located.

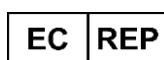

Accora Ltd, 38 Main Street,
Swords, Co. Dublin, Ireland, K67 E0A2
T: +353 (0)1 695 0614

GENERAL WARNINGS

1. Keep this Instruction Manual available for future reference.
2. These instructions must be observed to ensure the safe and effective use of this bed and the safety of users and carers.
3. This bed must be assembled, positioned and used in accordance with these instructions.
4. The safety features for operating the bed and instructions concerning the bed must be strictly observed.
5. This bed must not be exposed to smoke, naked flame, extreme temperature, flammable gases or other hazardous substances or situations.
6. Accora shall not be held liable for any damage, injuries or accidents arising from unauthorised modifications, non-genuine spare parts, negligence or use that is at variance with this manual which can result in serious injury or death.
7. Electrical equipment can be hazardous if misused or abused. Ensure the electrical supply cable is not damaged by crushing and does not create a trip hazard.
8. Only use side rails, and other accessories, that are compatible with this bed as supplied by Accora. Incompatible side rails can create serious hazards.
9. Keep children and pets away from this bed unless supervised by an adult as there is a risk of injury and/or choking on small parts.
10. Do not lower the bed while a hoist that extends beneath the bed is being used. Hoist access is obtained when the bed is raised to 45cm measured from the floor to the mattress platform base.
11. When routing cables for other electronic equipment used with the bed (e.g. air mattress pump), ensure cables cannot be squeezed, crushed or damaged by the moving parts on the bed.
12. The hand control should be positioned to avoid strangulation risk. Inappropriate use of the hand control (e.g. kinking, shearing) could lead to dangerous electric hazards. The bed must not be used if there is any visible damage to the handset or cable.
13. Never stand on the bed.
14. Inappropriate use of the power supply cable (e.g. kinking, shearing) could lead to dangerous electric hazards. The bed must not be used if there is any visible damage to this cable.
15. Inappropriate routing of accessory cables, e.g. mattress air pump cable, could lead to dangerous electric hazards if squeezed or crushed between moving parts. The bed must not be used if there is any visible damage to any cables.
16. The bed should be left in the Floor-Level position when the patient is unattended in order to reduce risk of injury due to falls.
17. If using the electronic functions adversely affects the health of the patient, disconnect the power supply and only use the bed in the static mode.
18. Do not move the bed when it is in the Floor-Level position.
19. This bed should not be used for transporting patients.
20. This bed is not recommended for users outside of the weight and height specifications detailed in Section 4
21. Do not modify this bed without the authorisation of Accora.
22. Before operating this bed, ensure the patient is safely positioned to reduce the risks of bed fall, entrapment and imbalance.
23. Always check for any entrapment risks under the bed before lowering to the Floor-Level position.
24. Electrical installations must meet local requirements. It is recommended that the bed is disconnected from the mains during exceptional cases (i.e. a storm).
25. Patients, or users, should be risk assessed to ensure they are able to understand this manual and to operate FloorBed safely without risk to themselves or others.
26. Patients or users should only be allowed to operate the bed independently if they are able to understand the safety instructions in this manual and have been risk assessed as appropriate to do so.
27. If the combined weight of the mattress and accessories exceeds 35kg, the maximum patient weight must be reduced accordingly.

1. Means of Delivery

WARNING

Extreme caution must be taken when moving the bed on the transport bracket to prevent the bed tipping over or moving unexpectedly.

The bed is supplied on a transport bracket. An inspection must take place upon receipt to ensure the delivery is complete and undamaged.

Any missing parts, faults or damage must be reported immediately to the carrier, and Accora, in writing.

When loading and unloading care must be taken that the transport bracket castors can rotate freely and the castor brakes are unlocked. These castors are designed for use in an indoor environment and for travel on even, smooth and clean floors, (e.g. ceramic floor tiles, linoleum, cast floors). The castors may become damaged when moving the bed along a rough, uneven or dirty surface.

2. Safety Instructions

1. Before using the bed, you must read the instruction manual and use the bed in accordance with it.
2. The bed must not be used if faults have been detected on it that may injure the patient, staff or a third person, the bed or the surroundings.
3. The bed must only be operated by persons who are able to operate it in accordance with the manual.
4. The operating staff must make the patient aware of the control functions that apply to the patient subject to an assessment by a professional.
5. Before using the bed, the operator should understand the bed and its functionality.
6. The safe working load, as specified in Section 4, must never be exceeded.
7. If there is a patient on the bed, the bed castors must be locked as an unlocked bed castor can cause injury to a patient who leaves the bed or changes position.
8. The height of the mattress platform must be adjusted to the correct height for the condition of the patient.
9. Only one person should occupy the bed at any time.
10. When operating the moving parts of the bed, care must be taken to ensure that the patient, other people and objects do not become trapped.
11. If a lifting pole or infusion stand is fixed to the bed, increased attention must be taken during

movement, lifting or tipping, to the space around the lifting pole and infusion stand, so that the equipment is not damaged.

12. Before cleaning the bed, the electrical supply must be disconnected.
13. The bed may not be used where there is a danger of explosion or in the presence of uncontained flammable liquids.
14. When repairing the bed, only original materials and components may be used, otherwise the manufacturer cannot guarantee against any damage that might occur.

3. Intended use

This bed is intended for use in the following application environments only:

1. Application Environment 3 - Long-term care in a medical area where medical supervision is required and monitoring is provided if necessary and ME equipment used in medical procedures may be provided to help maintain or improve the condition of the patient. Note, this includes use in nursing homes and in rehabilitation and geriatric facilities.
2. Application Environment 4 - Care provided in a domestic area where ME equipment is used to alleviate or compensate for an injury, disability or disease

It is essential to consult Accora in advance if you wish to use the bed for any purpose outside the use detailed in this manual. Electrical installations must meet local requirements. It is recommended that the bed is disconnected from the mains during exceptional cases (i.e. a storm).

4. Technical Specification

Environmental information:

Condition	Temperature Range	Relative Humidity	Atmospheric pressure
Operating	+10°C to +40°C +50°F to +104°F	30% to 75%	700 hPa to 1060 hPa
Transport/ storage	-20°C to +50°C -4°F to +122°F	(Non-condensing)	

If the bed is stored in conditions outside the normal operating range, it should be allowed time to stabilise, in normal operating conditions, before use.

Description	Value
Overall dimensions	1070mm W × 2240mm L (42in W × 88in L)
Mattress platform dimensions*	1050mm W × 2000mm L (41.25in W × 78.75in L)
Bed castor	4 x 75mm with brake (4 x 3in with brake)
Mattress platform height	78mm to 650mm (3in to 25.5in)
Max self-help pole lifting load	75kg (12st) (165lb)
Safe Working Load**	260kg (41st) (575lb)
Maximum Patient Weight**	225kg (35st) (495lb)
Audible noise	53Db (A) typical
Mass of Bed (excluding transport bracket)	113.3kg (18st) (250lb)
- Headboard	22.0kg (3.5st) (48.5lb)
- Footboard	20.5kg (3.25st) (45lb)
- Mattress platform, head end, frame	26.8kg (4.25st) (59lb)
- Mattress platform, foot end, frame (including joining bars)	19.0kg (3st) (42lb)
- Mattress platform, head end, profiling section	11.2kg (1.75st) (24.5lb)
- Mattress platform, foot end, profiling section	13.8kg (2st) (30.5lb)
Liquid Ingress Protection	IPX4 Splash resistant
Trendelenburg function	15 degrees
Expected service life	Typically, 5 years

FloorBed mattress platform range including maximum angles:

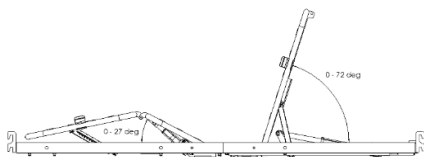

Key parts of the bed:

- 1 Headboard
- 2 Footboard
- 3 Mattress platform, head end
- 4 Mattress platform, foot end

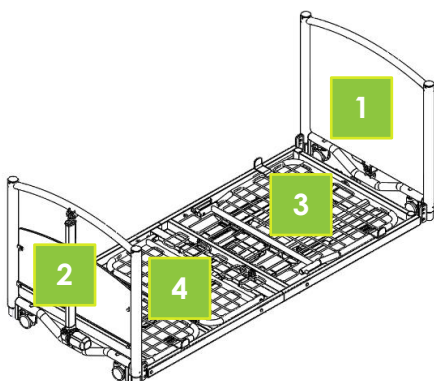

* The recommended patient height is 1460 – 1850mm. Taller patients may be accommodated by using a mattress platform extension. See Section 12.

** The safe working load is calculated as follows (as specified by EN 60601-2-52):

Maximum patient weight	225kg	35st	495lb
Mattress	20kg	3.5st	46lb
Accessories	15kg	2.5st	34lb
TOTAL (Safe working load)	260kg	41st	575lb

5. Accessories

Model number	NSB-0-FL5-200
Side rail - 2000mm / 78.7in	SDR-0-FL1-100
Side rail - 2200mm / 86.6in	SDREX-0-FL1-100
Mattress platform extension infill – 100mm/4.0in	LRPEX-0-FL5-200
Mattress platform extension infill – 200mm/7.9in	LRPEX-0-FL5-100
Standard bed lever	STLEV-0-FL1-100
Rotating bed lever	RTLEV-0-FL1-000
Trapeze self-assist lifting pole	LIFOL-0-FL1-000

6. Electrical specification

Duty Cycle: Intermittent operation 2 min/18 min; this implies that after the maximum continuous action of two minutes, there must be a break of 18 minutes.

Model number	NSB-0-FL5-200
Supply voltage	100 – 240V
Supply frequency	50/60Hz



The B symbol indicates this product has a degree of protection against electric shock for type B equipment.



Caution, read the instructions before use.



Degree of protection against liquid ingress.



Do not dispose of in household waste.



Degree of protection against electric shock: Class II Double Insulated.



For indoor use only

For or a full list and explanation of symbols used see Section 24.

7. Assembly

WARNING

Assembly MUST be carried out by suitably trained and qualified personnel.

All functions MUST be tested and approved after assembly by suitably trained and qualified personnel.

Assembly MUST take place in a clear, uncluttered area and children and pets should be kept away.

Only power supply supplied with bed may be used.

If bed has become soiled or contaminated during transit refer to cleaning and disinfection instructions.

Ensure headboard and footboard are assembled as shown below so that the Trendelenburg function works in a safe way.

1. Check that the delivery is complete and whether any visible damage has occurred to the bed during transport.
2. Identify all components:

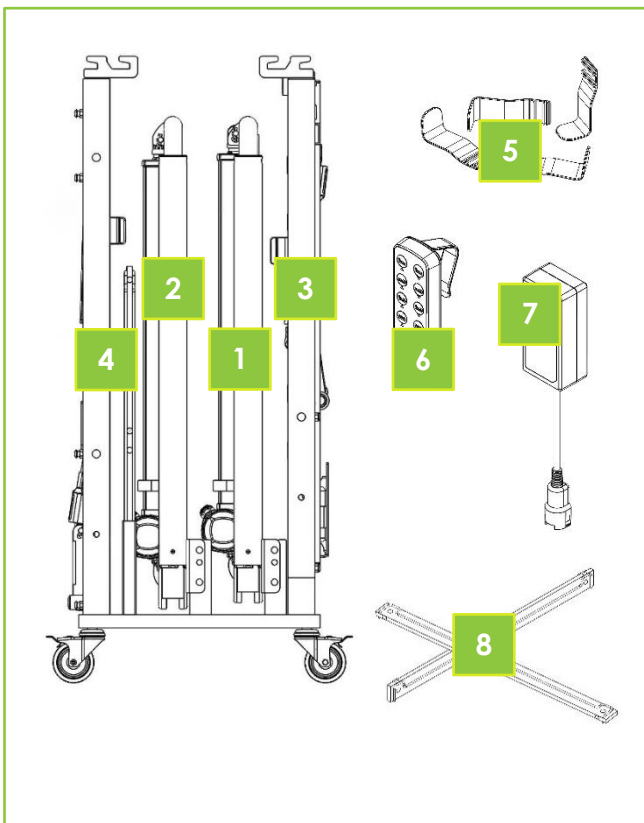

- | | |
|---|---------------------------------|
| 1 | Headboard |
| 2 | Footboard |
| 3 | Mattress platform, head section |
| 4 | Mattress platform, foot section |
| 5 | Mattress guides |
| 6 | Handset |
| 7 | Power supply |
| 8 | Mattress platform joining bars |

3. Ensure the transport bracket castors are positioned and locked as shown below. Remove the components from the transport bracket in the sequence shown below. Remove the locking pins and loosen the bolts (shown in red), one component at a time:
 - A. Mattress platform, head section
 - B. Mattress platform, foot section
 - C. Footboard
 - D. Headboard

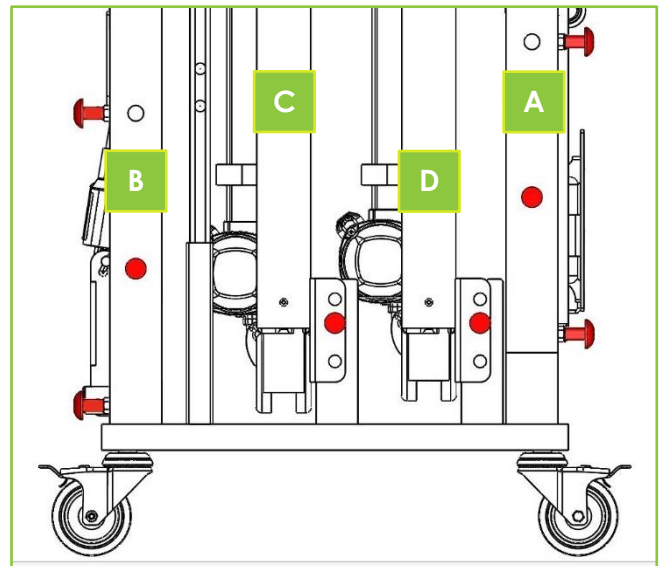

- Assemble the headboard and mattress platform head end as shown below. Insert locking pin and R-clip, as shown, in two positions.

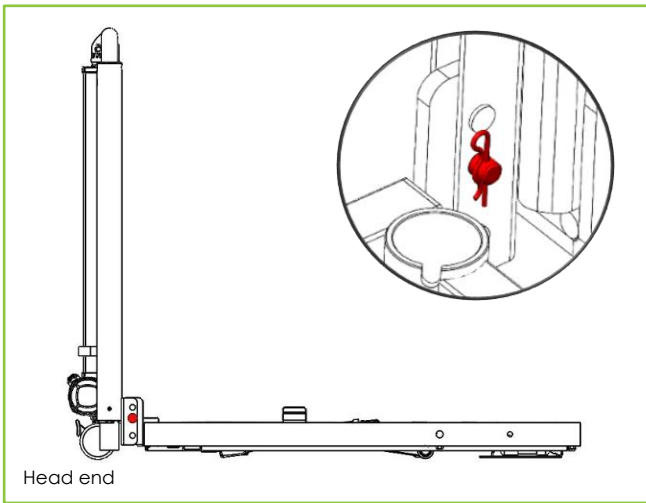

- Assemble the footboard and mattress platform foot end as 4 above. Insert locking pin and R-clip, as shown, in two positions.
- Insert two mattress platform joining bars into the head end and secure with locking pins and R-clips as shown in two positions.

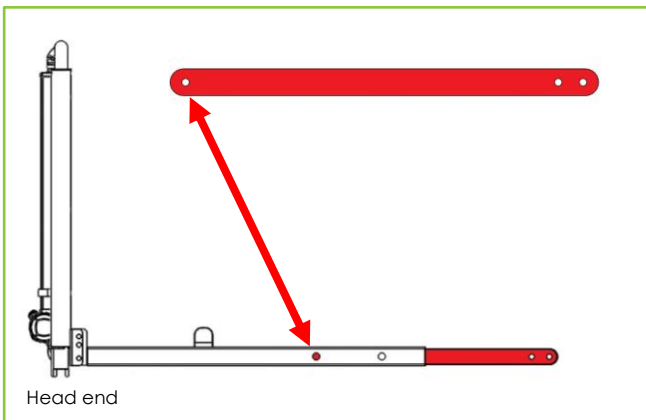

- Join the two parts of the bed together using the joining bars and secure with locking pins and R-clips as shown in two positions.

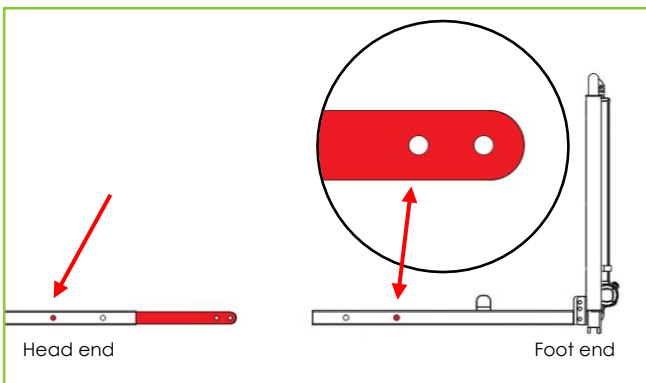

- The bed should now be assembled with 8 locking pins and R-clips located, 4 on each side, as shown below.

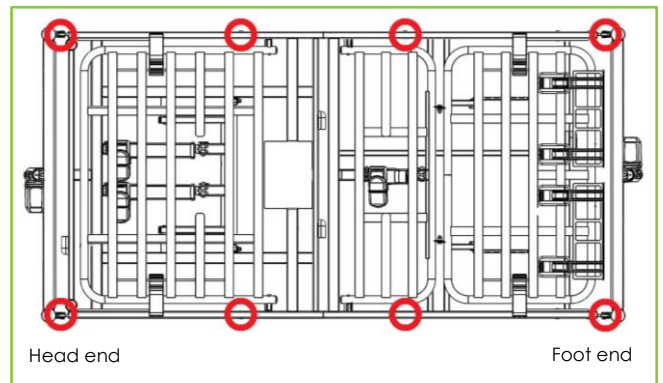
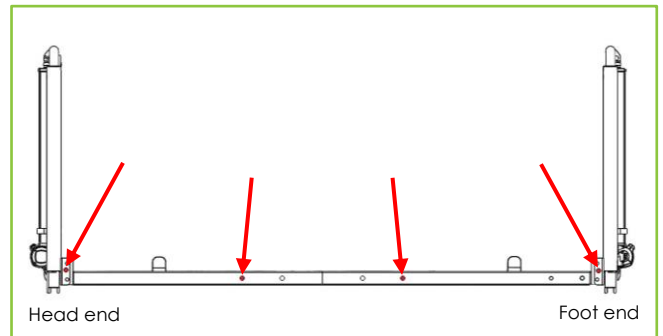

- Refer to the figure below. Plug in the four actuator cables (1) and fit the sliding protective cap (2) over each cable connector.

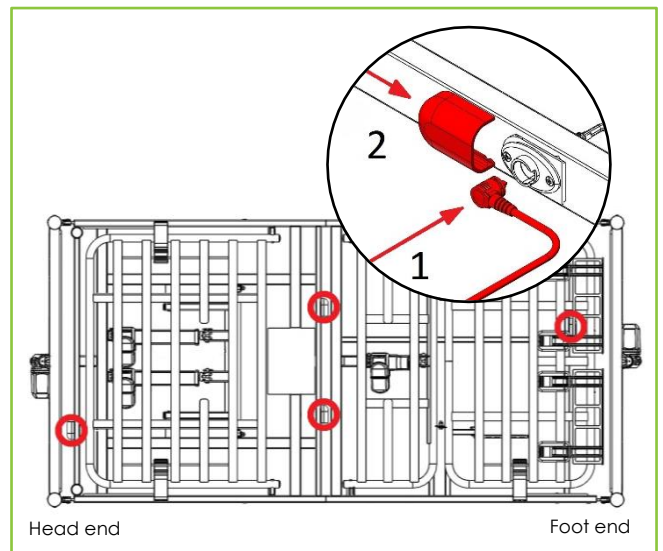

- Inspect all wiring for damage and risk of crushing before plugging the power supply cable into the bed supply cable (routed to the head end) and then the power supply into a mains supply socket.
- Remove red transport tie-downs from legrest and backrest enabling free movement of the profiling sections. Store for future use.

12. Using the handset, raise the mattress platform approximately 30cm. Tighten four locking screws under the mattress platform using a 5mm Allen key as shown.

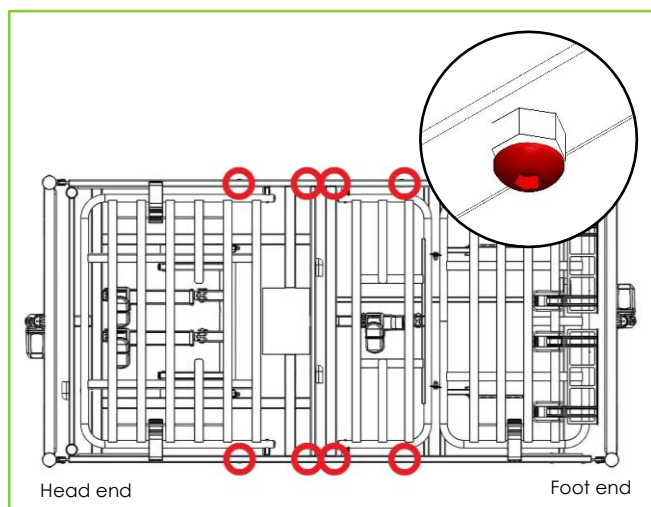

13. Fit the mattress guides in position as shown below. Select fitting slot by mattress width:
1. 1000mm/39.5in
 2. 1050mm/41.5in
 3. 1065mm/42.0in

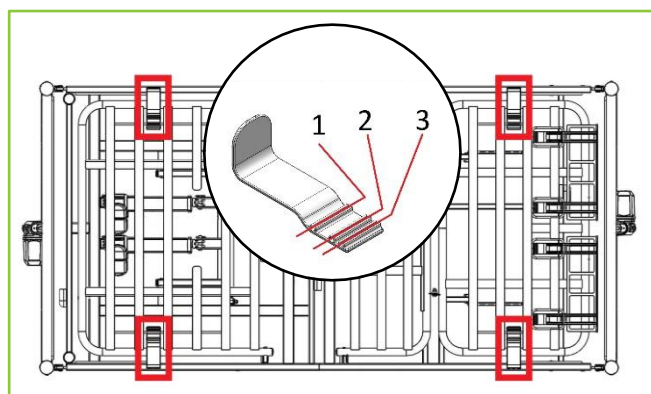

8. Bed controls and indicators

WARNING

Bed positioning **MUST** be carried out by suitably trained and qualified personnel.

Check for obstructions around, above and below the bed frame and position the bed so that it can operate through the full height range without any possibility of obstruction or entrapment.

The head end of the bed must be a minimum of 300mm from the wall. Always engage the brakes when the bed is stopped or left unattended.

Continued...

WARNING cont.

Patients should only be allowed to operate the bed independently if they are able to understand the safety instructions in this manual and have been risk assessed as appropriate to do so.

Always store the handset in a safe place when not in use to avoid risk of strangulation and entrapment in the bed mechanism.

Make sure the castor brakes are in the locked position before using the handset to change the positions of the bed.

The handset is used by the user or carer to change the position of the backrest and leg rest sections and to adjust the height of the mattress platform of the bed. Always check for obstructions before the bed is raised or lowered. Before using the control, the operating staff should explain to the patient how the bed can be positioned. If the medical staff state that the patient's medical condition is inappropriate for the patient to be able to adjust the bed independently, the bed's position must only be adjusted by the carer.

Always store the handset in a safe place when not in use to avoid risk of strangulation and entrapment in the bed mechanism. E.g. on the outside of the headboard or footboard.

The handset has the following controls and indicators:

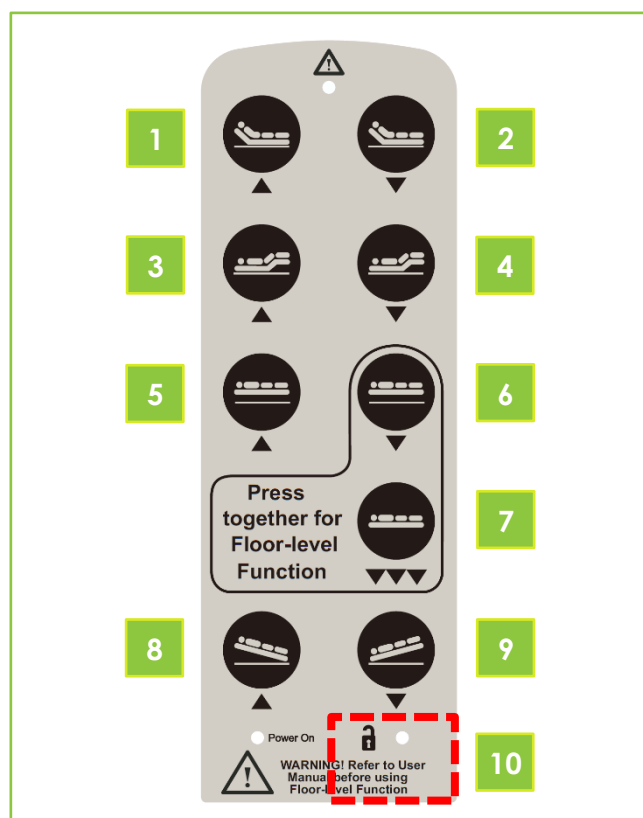

1

2

Backrest – Raise / Lower

3

4

Legrest – Raise / Lower

5

6

Bed – Raise / Lower

7

Floor-Level function safety button
(must be pressed together with
button number six)

8

9

Reverse Trendelenburg and
Trendelenburg function

10

Security key swipe area / lock out
indicator

The handset Power On light will illuminate ORANGE when the bed is plugged into a mains socket and switched on. When power is first switched on and the Power On light illuminates, the handset will be in a 'Locked Out' mode. The lock out indicator light (10) will not be illuminated and all functions will be locked.

The functions can be unlocked by using the security key. This key can be found secured to the handset cable. To activate the handset, the security key must be swiped across the lower part of the handset, as shown by the red dotted box on the diagram. There are different levels of functionality to unlock depending on how many times the key is swiped on the handset. The levels of functionality are as follows:

- First swipe** – The handset lock out indicator will illuminate GREEN. Buttons 1 to 8 will be activated which include Backrest, Leg rest, Floor-Level function and Reverse Trendelenburg.
NOTE: The Trendelenburg function (Button 9) will remain locked.
- Second swipe** – The handset lock out indicator will illuminate ORANGE. All 9 buttons will now be activated, including Trendelenburg. If the handset is not used it will auto-lock after a pre-set time. The handset lock out indicator will turn off and all functions will be locked.
- Third swipe** – The handset lock out status indicator will not be illuminated. The handset is now fully locked.

Note - If the patient is unable to operate the bed safely, lock the handset using the security key immediately after each use. (The security key may need to be swiped twice to fully lock. See 1 – 3 above. Full lock is confirmed by the lock out indicator turning off)

Safety stop position – The safety stop position is the position the bed will stop when lowering the bed using button 6. The mattress platform height is approximately 20cm. To use the Floor-Level function refer to Section 9.

9. Floor-Level function

WARNING

Extreme care must be taken when using the Floor-Level function.

Always check for any entrapment risk and obstructions under the bed before and during use of the Floor-Level function.

Keep children and pets away from the bed unless supervised by an adult.

Patients, users and operators must be risk assessed and made aware of the risks to themselves and those around before using the Floor-Level function of this bed.

Beware of trip hazard when the bed is in the Floor-Level position.

The Floor-Level function will lower the mattress platform to floor level. The mattress platform can be lowered to a height of just 7.8cm (3.1 in).

Safety Stop position – The Safety Stop position is the position the bed will stop when lowering the bed using button 6. To lower the bed to the Floor-Level, refer to the instructions below:

To use the Floor-Level function:

- Check underneath the bed to make sure there are no obstructions or entrapment risks.
- When lowering the bed, make sure the user or patient keeps hands and legs away from the edge of the mattress.
- Unlock the handset using the security key.
- Press button 6 to lower the bed until it reaches the safety stop position (approx. 20cm).
- Press buttons 6 and 7 together. The bed will now move down to the Floor-Level position.
NOTE: If both buttons are released, the bed will stop moving immediately.
- When the bed has reached the desired height, lock the handset and store the handset in a safe place.

10. Functionality check

WARNING

Functionality check **MUST** be carried out by suitably trained and qualified personnel.

Check for obstructions around, above and below the bed frame and position the bed so that it can operate through the full height range without any chance of obstruction or entrapment.

The head end of the bed must be a minimum of 300mm/11.8in from the wall. Always engage the brakes when the bed is stopped or left unattended.

Using the handset, test all bed functions and check all cables for risk of crushing. Refer to Section 8:

1. Raise the bed to full height (button 5)
2. Lower the bed until it stops at the Safety Stop position (button 6)
3. Use the safety double button action to activate the Floor-Level function and lower the bed to the Floor-Level position (buttons 6 & 7 pressed together)
4. Check all cables for risk of crushing.
5. Lift and lower backrest (buttons 1 & 2)
6. Lift and lower legrest (buttons 3 & 4)
7. Check the reverse Trendelenburg function (head up, feet down) (button 8). Trendelenburg function (head down, feet up) (button 9) should not activate unless this function is unlocked as described in Section 8.

Check the correct function of the castors and brake control. Check all functions of the handset.

11. Using the castor brakes

All four castors can be locked by pressing down on the lower lever of the castors; they can then be unlocked by pressing down on the top lever of the castors. Care must be taken to make sure the castor brakes are always locked when the bed is in use, being assembled or dismantled, so that the bed does not move accidentally.

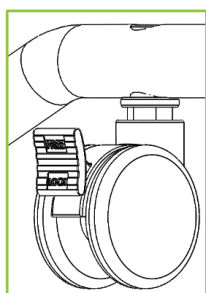

Brake locked

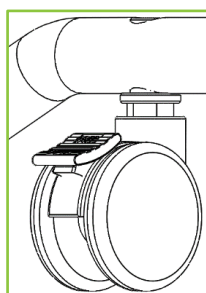

Brake unlocked

12. Mattress selection

WARNING

Incompatible mattresses can create hazards. Read instructions for use.

The distance from the top of the uncompressed mattress to the top of the siderail, if fitted, must always be greater than 220mm/8.7in.

Where a speciality mattress or mattress overlay is used and the distance from the top of the uncompressed mattress to the top of the siderail, if fitted, is less than 220mm/8.7in a risk assessment must be performed to assure equivalent safety.

Bed extension **MUST** be carried out by suitably trained and qualified personnel. The appropriate infill piece **MUST** be used, failure to do so will result in unacceptable gaps and risk of injury and entrapment.

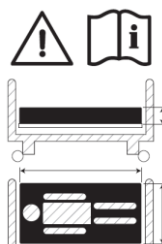

Please contact Accora for compatible mattresses.

Incompatible mattresses can create hazards.

All mattresses must be fitted and used in accordance with the mattresses manufacturer or supplier's instructions.

Model number	NSB-0-FL5-200
Mattress size – Standard Configuration	2000 x 1050mm 78.7 x 41.5in
Mattress size – Extended configuration*	2200 x 1050mm 86.6 x 41.5in
200mm Mattress platform extension part number	LRPEX-0-FL5-200

* Mattress platform extension infill piece **MUST** be used if the mattress platform is extended.

13. Siderail selection

WARNING

Only use side rails that are compatible with this bed as supplied by Accora.

Incompatible siderails can create hazards.

14. Disassembly

WARNING

Disassembly **MUST** be carried out by suitably trained and qualified personnel.

The bed must be disconnected from the power supply before disassembly.

Disassembly must take place in a clear, uncluttered area and children and pets should be kept away.

If bed has become soiled or contaminated during use refer to cleaning and disinfection instructions.

Extreme caution must be taken when moving the bed on the transport bracket to prevent the bed tipping over or moving unexpectedly.

Do not move the bed when the power supply is plugged in to the mains supply socket.

1. Remove all accessories, e.g. mattress, side rails, bed levers etc.
2. Using the handset, raise the mattress platform approximately 30cm. Loosen the 4 mattress platform joining bar locking screws. (Do not remove the R-clips and locking pins at this stage)
3. Secure the backrest and legrest in the flat position with the red transport tie-downs provided.
4. Lower the mattress platform to the Floor-Level position and disconnect the power supply.
5. Remove actuator plug sliding covers and unplug 4 actuators. Replace sliding covers. Ensure loose cables are secured to prevent damage during transit.
6. Remove the central joining bar R-clips and locking pins and separate the bed into two halves.
7. Dismantle the headboard/mattress platform head end and footboard/mattress platform foot end by removing the R-clips and locking pins.
8. Ensure the disassembled parts are fitted to the transport bracket in the following order and positioned as shown in Section 7:
 1. Headboard (D in Section 7)
 2. Footboard (C in Section 7)
 3. Mattress platform foot section (B in Section 7)
 4. Mattress platform head section (A in Section 7)
 5. Ensure all R-clips and pins are refitted so that the bed on the transport bracket is safe to move.
 6. Ensure all wires are secured to prevent damage.

15. Moving and Repositioning

WARNING

Moving or repositioning **MUST** be carried out by suitably trained and qualified personnel.

All functions **MUST** be tested and approved by a competent person after moving or repositioning.

Only power supply supplied with bed may be used.

Do not move the bed in the Floor-Level position.

Do not move or reposition the bed with service user or patient on the bed.

Do not move the bed when the power supply is plugged in to the mains supply socket.

1. Ensure the bed is at the Safety Stop position (see Section 8 & 9).
2. Disconnect the power.
3. Secure the handset, power supply and all cables to prevent damage.
4. Unlock the castors and move the bed.
5. When the bed has been moved or repositioned, lock all the castors as described in Section 11 and perform full functionality check as described in Section 10.

16. Cleaning & Disinfection

WARNING

The bed must be disconnected from the power supply when being cleaned or disinfected.

All functions **MUST** be tested and approved by a competent person after cleaning or disinfection.

The bed **MUST** be cleaned and disinfected before re-using the bed for a different patient

Cleaning Information:

To disinfect the bed, only use detergents designed for use in healthcare. Do not use abrasives, scourers or other materials that could damage the coating. Do not use corrosives, caustics or strong acids. Do not use detergents that could alter the structure or behaviour of the plastics (petrol etc.).

Clean by wiping with a damp cloth.

The bed is not designed for maintenance in automatic bed washers or for cleaning with pressurised water, spraying, showering or steam cleaning.

Accora cannot be liable for any damage or risk of damage if inappropriate cleaning or disinfectant agents are used.

Cleaning procedure:

1. Remove all accessories, mattress etc.
2. Adjust the mattress platform to the highest position and adjust the position of the Backrest and Footrest to provide access for cleaning all the platform parts.
3. Disconnect the bed from the power supply.
4. Move the bed to where cleaning will take place and lock the bed castors.
5. Clean as described in the "Cleaning Information".

17. Troubleshooting

WARNING

Troubleshooting **MUST** be carried out by suitably trained and qualified personnel.

Do not attempt to open any electrical part enclosures.

Do not attempt to repair any electrical parts.

All functions **MUST** be tested and approved by a competent person after troubleshooting

The FloorBed does not function correctly:

1. Is the 'Power on' indicator light on the handset illuminated? If the light is not illuminated:
 - a. Is the power supply plugged in and turned on?
 - b. Is the power lead in-line socket plugged in correctly?
 - c. If the 'Power on' indicator light is still not illuminated, contact Accora for further advice.
2. If the 'Power on' indicator light is on, has the handset been unlocked? If not, refer to Section 8.
3. If the handset has been unlocked and the FloorBed still does not function correctly, contact Accora for further advice.

If the FloorBed does not stop at the Safety Stop position, check the main lift actuators are correctly plugged in at all points between the actuator and the control box.

If the FloorBed still does not function correctly, contact Accora for further advice.

18. Storage

For problem-free storage we recommend:

1. Disconnect the bed from the electric supply
2. Remove the accessories
3. Wrap the bed and accessories or cover them so that the coating and plastic parts are not damaged
4. Bed should be stored in a temperature between -20°C to +50°C, -4°F to +122°F
5. Bed should be stored in a relative humidity (non-condensing) between 30% and 75%

19. Daily Inspection

Daily visual inspection is strongly recommended and may be carried out by carer, user or other person.

The following checks must be carried out:

1. Does the bed operate as per its intended purpose without unexpected noise or motion?
2. Are there any signs of abuse or excessive wear?
3. Are all fixtures and fittings tight and secure?
4. Does the bed frame appear stable and secure?
5. Are all accessories fitted in line with the accessory manufacturer or accessory supplier's instructions?
6. Are all the castor brakes in the locked position?
7. Are all electrical cables (including accessories, e.g. mattress air pump) secured and routed to prevent damage?
8. Does the handset locking function work correctly? (See Section 8)
9. Does the bed stop at the Safety Stop position? (See Section 8 & 9)
10. Is the area around, above and below bed clear of possible obstruction?
11. Is there any risk of entrapment or patient injury?
12. Are any electrical cables pinched, crushed or damaged in any way?

If any damage, performance issue or cause for concern is noted during this inspection the bed should be withdrawn from service and appropriate steps should be taken.

20. General maintenance

WARNING

Maintenance **MUST** be carried out by suitably trained and qualified personnel.

All functions **MUST** be tested and approved after maintenance by suitably trained and qualified personnel. Refer to Section 10.

Only power supply supplied with bed may be used.

Do not carry out maintenance with service user or patient on the bed.

For information on service and repair of the FloorBed bed, refer to the service manual, SER-FL1-001EN. Repairs to the FloorBed bed must be carried by suitably trained and qualified personnel.

21. Guarantee

Model number	NSB-0-FL5-200
Warranty period	2 years

If the bed was acquired for a care home, the care home maintenance department should contact Accora to obtain the necessary parts.

22. Disposal of the FloorBed

In the event of the disposal of materials from the bed, end-of-life parts must be disposed of in accordance with current environmental regulations.

23. EMC Statement

Guidance and manufacturer's declaration-electromagnetic emissions		
<p>The bed is intended for use in the electromagnetic environment specified below. The customer or the user of the bed should assure that it is used in such an environment.</p>		
Emission test	Compliance	Electromagnetic environment-guidance
RF emissions CISPR 11	Group 1	The bed uses RF energy only for its internal function. Therefore, its RF emissions are very low and are not likely to cause any interference in nearby electronic equipment.
RF emissions CISPR 11	Class B	The bed is suitable for use in all establishments, including domestic establishments and those directly connected to the public low-voltage power supply network that supplies buildings used for domestic purposes.
Harmonic emissions IEC 61000-3-2	Class A	
Voltage fluctuations /flicker emissions IEC 61000-3-3	Compliance	

Guidance and manufacturer's declaration-electromagnetic immunity

The bed is intended for use in the electromagnetic environment specified below.

The customer or the user of the bed should assure that it is used in such an environment.

Immunity test	IEC 60601 test level	Compliance level	Electromagnetic environment-guidance
Electrostatic discharge(ESD) IEC 61000-4-2	+ 6 kV contact + 8 kV air	+ 6 kV contact + 8 kV air	Floors should be wood, concrete or ceramic tile. If floors are covered with synthetic material, the relative humidity should be at least 30%
Electrical fast transient/burst IEC 61000-4-4	+ 2kV for power supply lines + 1kV for input/output lines	+ 2kV for power supply lines Not applicable	Mains power quality should be that of a typical commercial or hospital environment.
Surge IEC 61000-4-5	+ 1kV line(s) to line(s) + 2kV line(s) to earth	+ 1kV differential mode Not applicable	Mains power quality should be that of a typical commercial or hospital environment.
Voltage Dips, short interruptions and voltage variations on power supply input lines IEC 61000-4-11	<5% UT(>95% dip in UT) for 0,5 cycle 40% UT(60% dip in UT) for 5 cycles 70% UT(30% dip in UT) for 25 cycles <5% UT(>95% dip in UT) for 5 s	<5% UT(>95% dip in UT) for 0,5 cycle 40% UT(60% dip in UT) for 5 cycles 70% UT(30% dip in UT) for 25 cycles <5% UT(>95% dip in UT) for 5 s	Mains power quality should be that of a typical commercial or hospital environment. If the user of the bed requires continued operation during power mains interruptions, it is recommended that the bed be powered from an uninterruptible power supply or a battery.
Power frequency(50, 60 Hz) magnetic field IEC 61000-4-8	3 A/m	3 A/m	The bed power frequency magnetic fields should be at levels characteristic of a typical location in a typical commercial or hospital environment.

NOTE UT is the a.c. mains voltage prior to application of the test level.

Guidance and manufacturer's declaration-electromagnetic immunity

The bed is intended for use in the electromagnetic environment specified below.

The customer or the user of the bed should assure that is used in such and environment.

Immunity test	IEC 60601 test level	Compliance level	Electromagnetic environment-guidance
Conducted RF IEC 61000-4-6	3 Vrms 150 KHz to 80 MHz	3 Vrms	<p>Portable and mobile RF communications equipment should be used no closer to any part of the bed including cables, than the recommended separation distance calculated from the equation applicable to the frequency of the transmitter.</p> <p>Recommended separation distance: $d = 1,2 \sqrt{P}$ $d = 1,2 \sqrt{P}$ 80MHz to 800 MHz $d = 2,3 \sqrt{P}$ 800MHz to 2,5 GHz</p> <p>Where P is the maximum output power rating of the transmitter in watts (W) according to the transmitter manufacturer and d is the recommended separation distance in metres (m).</p> <p>Field strengths from fixed RF transmitters, as determined by an electromagnetic site survey, a should be less than the compliance level in each frequency range Interference may occur in the vicinity of equipment marked with the following symbol:</p> 
Radiated RF IEC 61000-4-3	3 V/m 80MHz to 2,5 GHz	3 V/m	

NOTE1 At 80 MHz and 800 MHz, the higher frequency range applies.

NOTE2 These guidelines may not apply in all situations. Electromagnetic propagation is affected by absorption and reflection from structures, objects and people.

a Field strengths from fixed transmitters, such as base stations for radio (cellular/cordless) telephones and land mobile radios, amateur radio, AM and FM radio broadcast and TV broadcast cannot be predicted theoretically with accuracy. To assess the electromagnetic environment due to fixed RF transmitters, an electromagnetic site survey should be considered. If the measured field strength in the location in which the bed is used exceeds the applicable RF compliance level above, the bed should be observed to verify normal operation. If abnormal performance is observed, additional measures may be necessary, such as re-orienting or relocating the bed.

b Over the frequency range 150 kHz to 80 MHz, field strengths should be less than 3 V/m.

Recommended separation distance between portable and mobile RF communications equipment and the bed.

The bed is intended for use in an electromagnetic environment in which radiated RF disturbances are controlled.

The customer or the user of the bed can help prevent electromagnetic interference by maintaining a minimum distance between portable and mobile RF communications equipment (transmitters) and the bed as recommended below, according to the maximum output power of the communications equipment.

Rated maximum output power of transmitter W	Separation distance according to frequency of transmitter m		
	150 kHz to 80 MHz $d = 1,2\sqrt{P}$	80 MHz to 800 MHz $d = 1,2\sqrt{P}$	800 MHz to 2,5 GHz $d = 2,3\sqrt{P}$
0,01	0,12	0,12	0,23
0,1	0,38	0,38	0,73
1	1,2	1,2	2,3
10	3,8	3,8	7,3
100	12	12	23

For transmitters rated at a maximum output power not listed above, the recommended separation distance d in metres (m) can



















be estimated using the equation applicable to the frequency of the transmitter, where p is the maximum output power rating of

the transmitter in watts (W) according to the transmitter manufacturer.

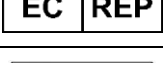
NOTE1 At 80 MHz and 800 MHz, the separation distance for the higher frequency range applies.

NOTE2 These guidelines may not apply in all situations. Electromagnetic propagation is affected by absorption and reflection from structures, objects and people.

24. Table of symbols

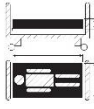
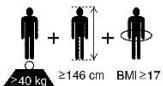
	Warning, beware of potential hazard – refer to instruction for use
	Refer to instructions for use
	Complies with the European Medical Device Regulation 2017/745
	Complies with the Medical Devices Regulations 2002 as amended.
	Model number
	Serial number
	Safe working load (SWL) – Maximum weight the bed can safely carry including the patient, mattress and accessories fitted
	Maximum patient weight
	Manufactured date
	Manufacturer
	Warning, Floor-Level function and keep clear from obstructions
	Medical Device in accordance with EU Medical Device Regulation 2017/745
	EC Representative
	Floor-Level function warning
	Ensure the side rails are compatible with the bed before fitting
	Warning, weight over 20kg (44lbs)
	Patent pending label
	Unique Device Identification (UDI) label
	Warning, use compatible mattresses only
	Physical description of an adult

25. Contact details

	UK and Rest of World	USA
Address	Accora Ltd. Charter House Barrington Road Orwell Cambridge SG8 5QP UK	Accora Inc. 9210 Corporate Blvd. Suite 120 Rockville MD 20850 USA
Telephone	+44 (0)1223 206100	+1 301-560-2400
Email	info@accora.care	information@accora.care
Website	www.accora.care	www.accora.care

Accora



Accora
Barrington Road
Orwell
Cambridge
SG8 5QP
United Kingdom

T: +44 (0)1223 206100
info@accora.care
www.accora.care